

# new to range

AUGUST 2020



**aplus**<sup>®</sup>  
Automotive Parts

## AIR TANKS

[www.aplus-automotive.com](http://www.aplus-automotive.com)



99128AP

SCANIA

AIR TANK

HAVA TANKI

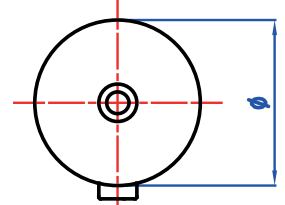
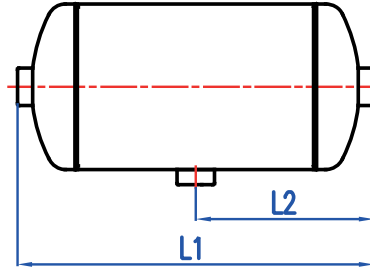
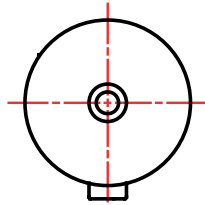

OEM / COMPARISON NO		LITER LITRE	Ø	↔ L1 / L2			TYPE / TIP
1360400 1383853	14,5 bar	8	154 mm	486 / 243 mm	5,2 kg	M22x1,5	

99139AP

MAN

AIR TANK

HAVA TANKI

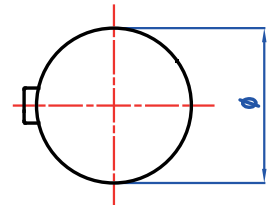
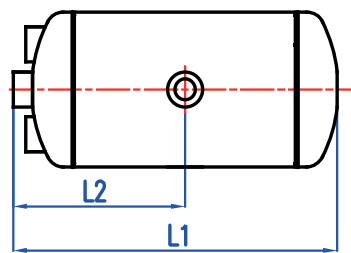
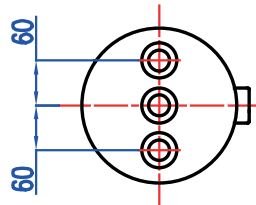

OEM / COMPARISON NO		LITER LITRE	Ø	↔ L1 / L2			TYPE / TIP
81514010179 81514010203 81514010237 81514010248 81514010252 81514016016	12,5 bar	8	206 mm	294 / 154 mm	5 kg	M22x1,5	



99143AP

**WABCO**

**AIR TANK**

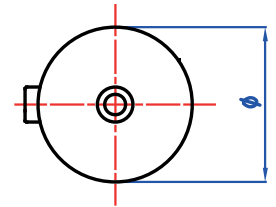
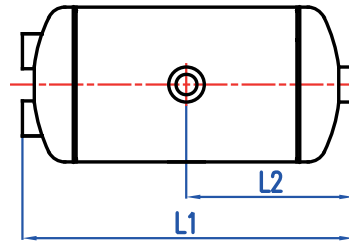
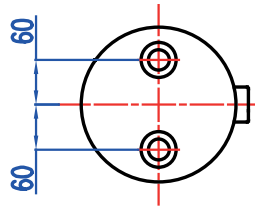
**HAVA TANKI**

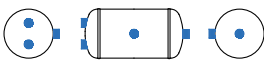

OEM / COMPARISON NO		LITER LITRE	Ø	↔ L1 / L2			TYPE / TİP
9504109020	15,5 bar	10	206 mm	355 / 182 mm	5,7 kg	M22x1,5	





99150AP

**MERCEDES BENZ**

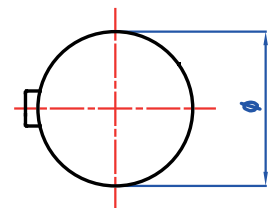
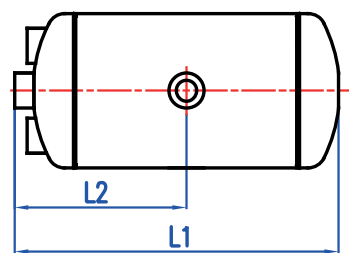
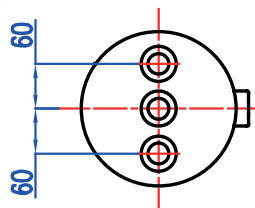
**AIR TANK**

**HAVA TANKI**



OEM / COMPARISON NO		LITER LITRE	Ø	↔ L1 / L2			TYPE / TİP
0044320801 0054323301 0064323701	15,5 bar	10	206 mm	366 / 190 mm	5,9 kg	M22x1,5	

99247AP

**VOLVO, RENAULT**

**AIR TANK**

**HAVA TANKI**

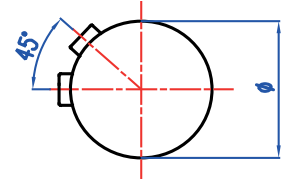
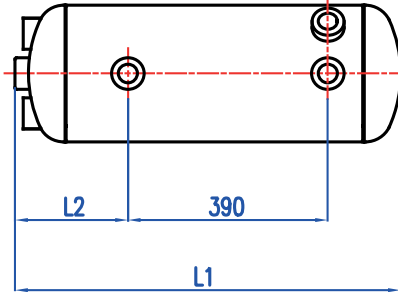
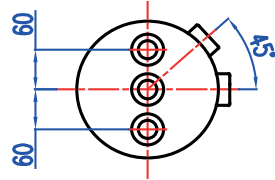

OEM / COMPARISON NO		LITER LITRE	Ø	↔ L1 / L2			TYPE / TİP
20904411M 5010525149	15 bar	40	276 mm	740 / 208 mm	14,4 kg	M22x1,5	

99248AP

**MERCEDES BENZ**

**AIR TANK**

**HAVA TANKI**

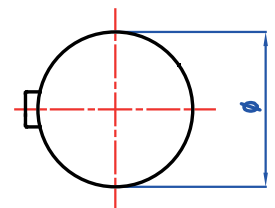
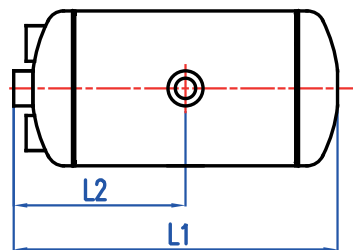
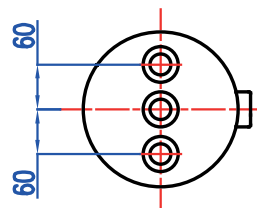

OEM / COMPARISON NO		LITER LITRE	Ø	↔ L1 / L2			TYPE / TİP
0034323901 0054322501 0064325701	15,5 bar	40	276 mm	758 / 386 mm	14,5 kg	M22x1,5	





99254AP

**MERCEDES BENZ**

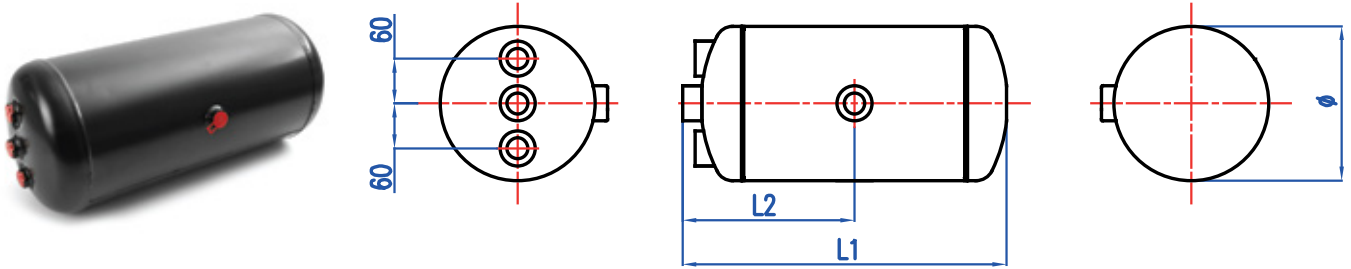
**AIR TANK**

**HAVA TANKI**



OEM / COMPARISON NO	 15,5 bar	LITER LİTRE 45	∅ 276 mm	↔ L1 / L2 844 / 429mm	 16 kg	 M22x1,5	TYPE / TİP
0034329901 0054322801 0064325801							





99267AP

**DAF**

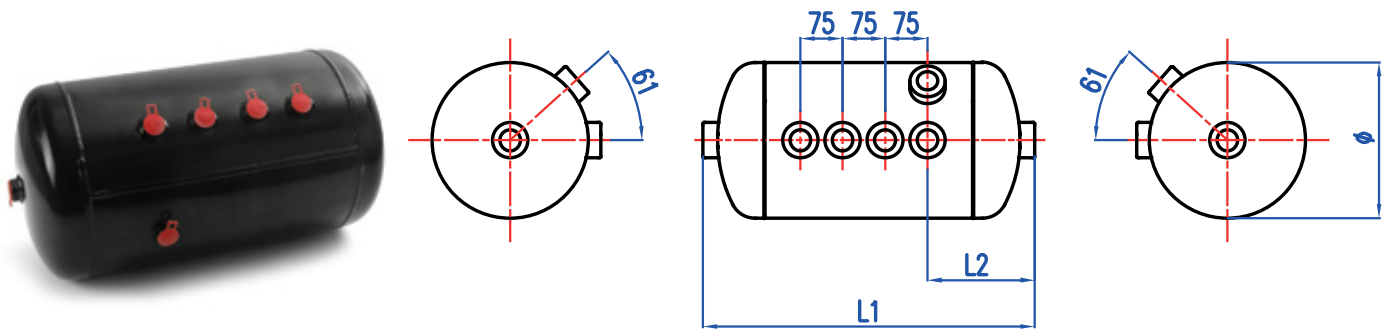
**AIR TANK**

**HAVA TANKI**



OEM / COMPARISON NO	 12,5 bar	LITER LİTRE 36	∅ 300 mm	↔ L1 / L2 609 / 200 mm	 13,1 kg	 M22x1,5	TYPE / TİP
1696171							





99273AP

MAN

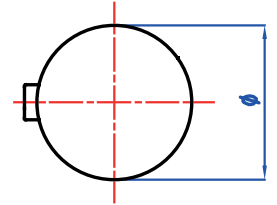
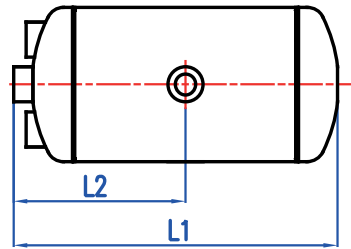
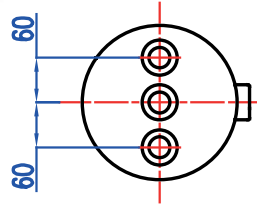
AIR TANK

HAVA TANKI



OEM / COMPARISON NO		LITER LITRE	Ø	↔ L1 / L2			TYPE / TİP
81514010228 81514010238 81514010257 81514016029	12,5 bar	20	310 mm	324 / 169 mm	8,1 kg	M22x1,5	



99286AP

SCHMITZ

AIR TANK

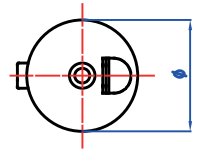
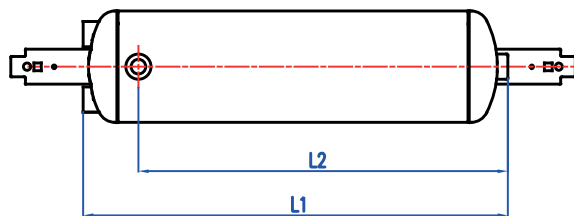
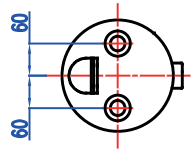
HAVA TANKI



OEM / COMPARISON NO		LITER LITRE	Ø	↔ L1 / L2			TYPE / TİP
1189864	12,5 bar	80	246 mm	1157 / 1014 mm	25	M22x1,5	