

# new to range

NOVEMBER 2020



**aplus**<sup>®</sup>  
Automotive Parts

## AIR TANKS

[www.aplus-automotive.com](http://www.aplus-automotive.com)



99173AP

**MERCEDES BENZ**

**AIR TANK**

**HAVA TANKI**

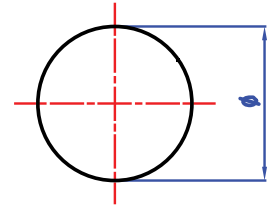
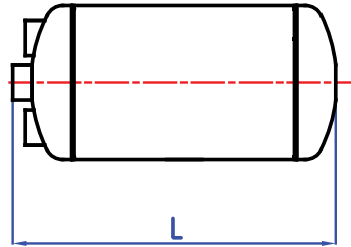
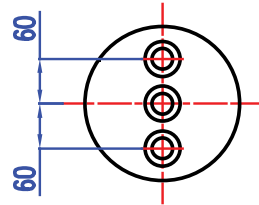

OEM / COMPARISON NO		LITER LİTRE	∅	↔ L1 / L2			TYPE / TİP
0034324101 0064328001 0064324201	15,5 bar	10	246 mm	277	5,5 kg	M22x1,5	

99221AP

**RENAULT**

**AIR TANK**

**HAVA TANKI**

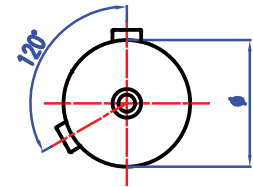
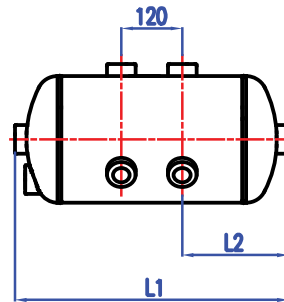
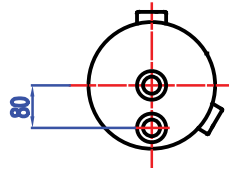

OEM / COMPARISON NO		LITER LİTRE	∅	↔ L1 / L2			TYPE / TİP
5010525446	13 bar	30	250 mm	750 / 293 mm	12,5 kg	M22x1,5	





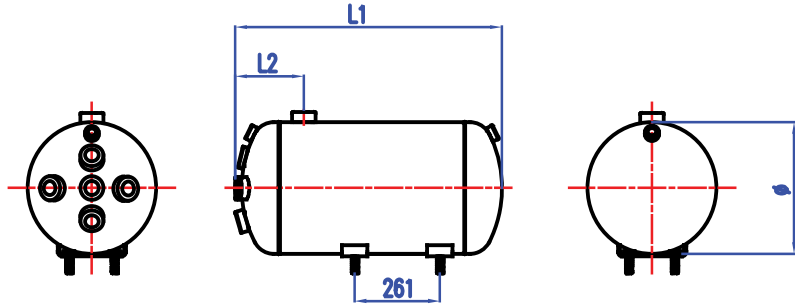

99222AP

**VOLVO**

**AIR TANK**

**HAVA TANKI**

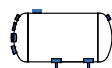

OEM / COMPARISON NO		LITER LITRE	Ø	↔ L1 / L2			TYPE / TİP
20946636	10 bar	35	255 mm	759 / 175 mm	14 kg	M22x1,5 M16x1,5 1/4" NPT	  





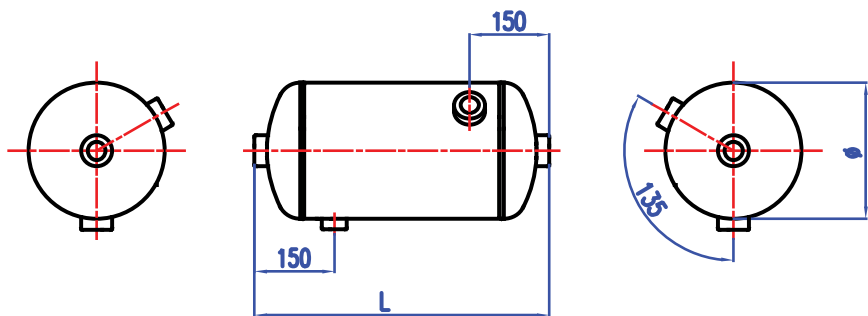

99265AP

**RENAULT**

**AIR TANK**

**HAVA TANKI**

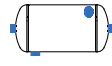

OEM / COMPARISON NO		LITER LITRE	Ø	↔ L1 / L2			TYPE / TİP
5010525418	13 bar	30	300 mm	515 mm	11,1 kg	M22x1,5	  





99272AP

RENAULT

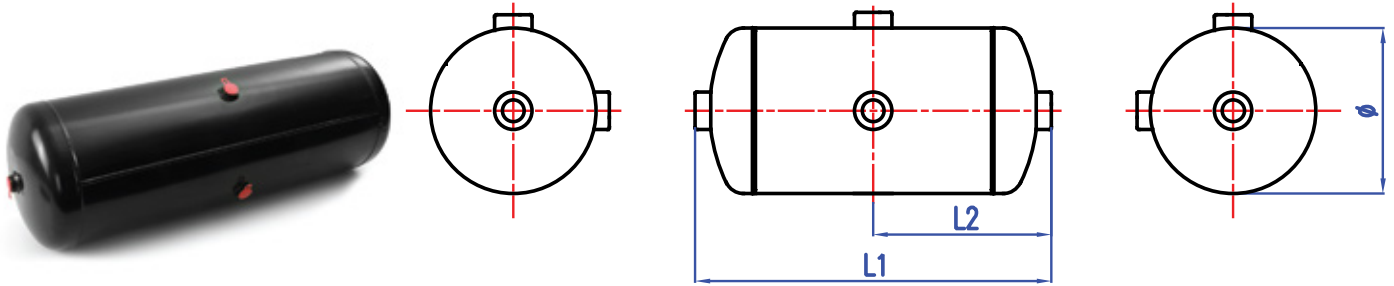
AIR TANK

HAVA TANKI



OEM / COMPARISON NO		LITER LITRE	Ø	↔ L1 / L2			TYPE / TİP
1518200 5021170393	12,5 bar	60	300 mm	966 / 483 mm	19,5 kg	M22x1,5	



99278AP

MAN

AIR TANK

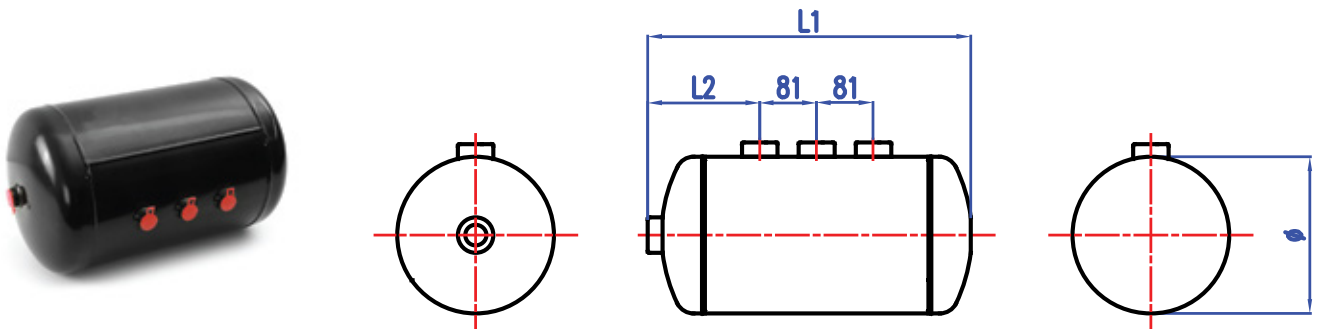
HAVA TANKI

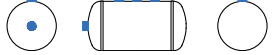

OEM / COMPARISON NO		LITER LITRE	Ø	↔ L1 / L2			TYPE / TİP
81514010259 81514016038 81514016156	12,5 bar	35	310 mm	529 / 190 mm	12 kg	M22x1,5	



99290AP

MAN

**AIR TANK**

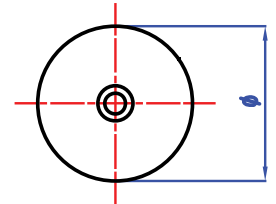
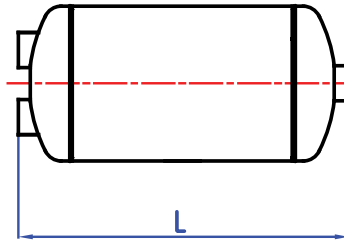
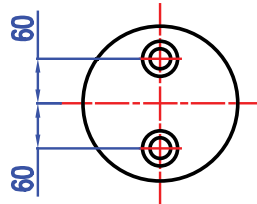
**HAVA TANKI**

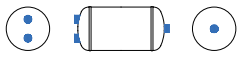

OEM / COMPARISON NO	 12,5 bar	LITER LITRE	Ø	↔ L1 / L2	 13,2 kg	 M22x1,5	TYPE / TİP
81514010232 81514010233 81514010242 81514016033		30	396 mm	345 mm			





99291AP

RENAULT, VOLVO

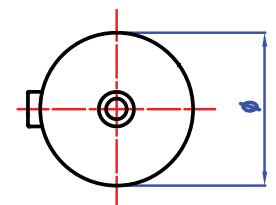
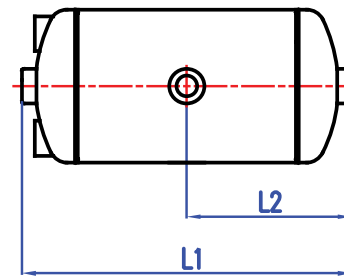
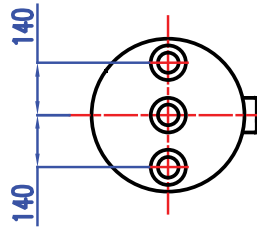
**AIR TANK**

**HAVA TANKI**



OEM / COMPARISON NO	 15 bar	LITER LITRE	Ø	↔ L1 / L2	 15,1 kg	 M22x1,5	TYPE / TİP
21187795 7421187795		39	396 mm	417 / 208 mm			





99296AP

**SCHMITZ**

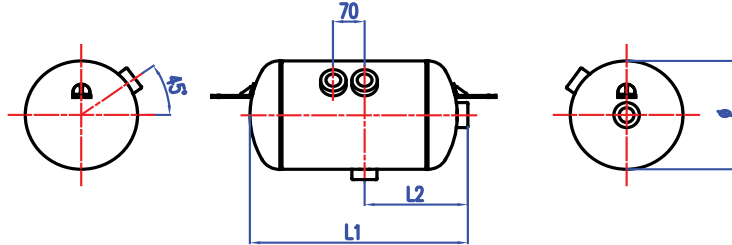
**AIR TANK**

**HAVA TANKI**



OEM / COMPARISON NO		LITER LITRE	Ø	↔ L1 / L2			TYPE / TİP
1009330 115826 1189863 1193012 1219118	10 bar	80	396 mm	743 / 340 mm	26 kg	M22x1,5	





99297AP

**KRONE**

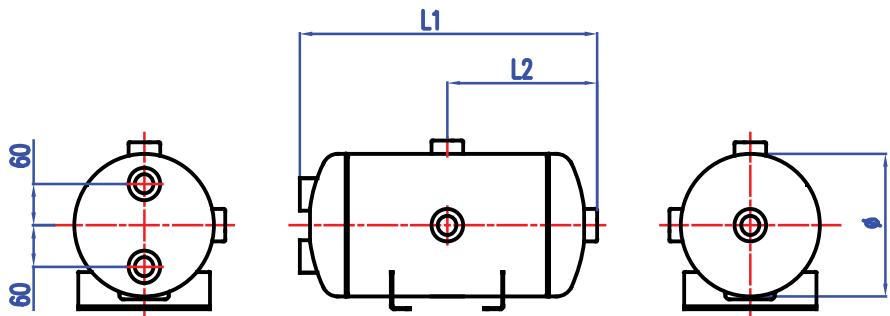
**AIR TANK**

**HAVA TANKI**



OEM / COMPARISON NO		LITER LITRE	Ø	↔ L1 / L2			TYPE / TİP
505821336	10 bar	80	396 mm	750 / 380 mm	26,9 kg	M22x1,5	

99298AP

IVECO

**AIR TANK**

**HAVA TANKI**

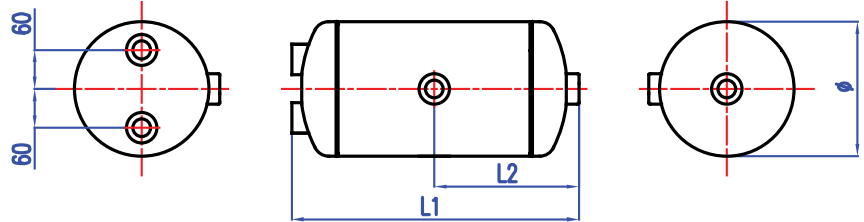

OEM / COMPARISON NO		LITER LITRE	Ø	↔ L1 / L2			TYPE / TİP
504197591 5801545818	12,5 bar	80	396 mm	750 / 380 mm	25 kg	M22x1,5	

99299AP

SCANIA, WABCO

**AIR TANK**

**HAVA TANKI**

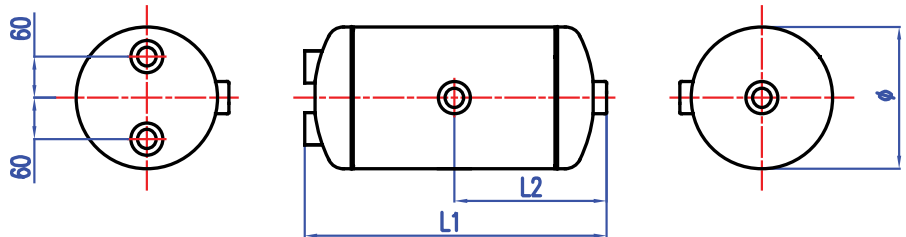

OEM / COMPARISON NO		LITER LITRE	Ø	↔ L1 / L2			TYPE / TİP
1935520 9501000020	10 bar	100	396 mm	915 / 462 mm	29,9 kg	M22x1,5	





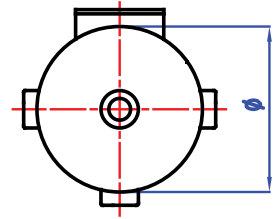
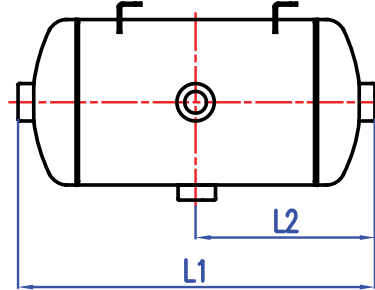
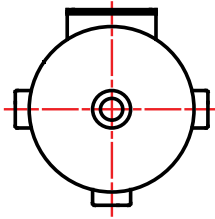

99302AP

DİĞER

## AIR TANK

## HAVA TANKI



OEM / COMPARISON NO		LITER LİTRE	Ø	↔ L1 / L2			TYPE / TİP
SPA190	12,5 bar	60	300 mm	910 / 455 mm	19,2 kg	M22x1,5	  





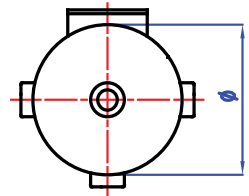
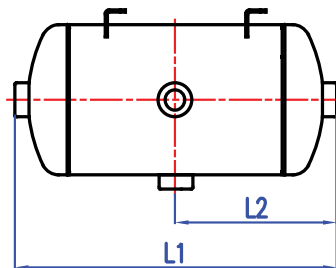
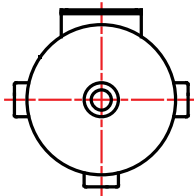

99303AP

DİĞER

## AIR TANK

## HAVA TANKI

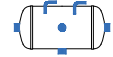

OEM / COMPARISON NO		LITER LİTRE	Ø	↔ L1 / L2			TYPE / TİP
SPA185M SPA188	12,5 bar	60	300 mm	912 / 456 mm	19,9 kg	M22x1,5	  







99304AP

DİĞER

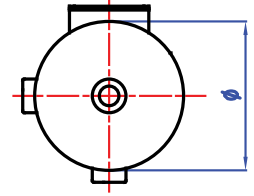
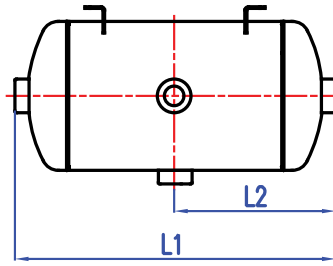
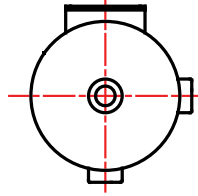
## AIR TANK

## HAVA TANKI

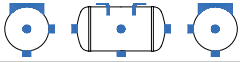

OEM / COMPARISON NO		LITER LİTRE	Ø	↔ L1 / L2			TYPE / TİP
SPA189	12,5 bar	60	300 mm	910 / 455 mm	19,1 kg	M22x1,5	





99305AP

DİĞER

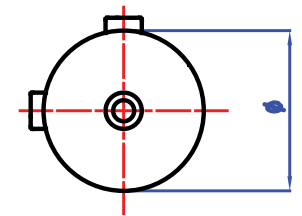
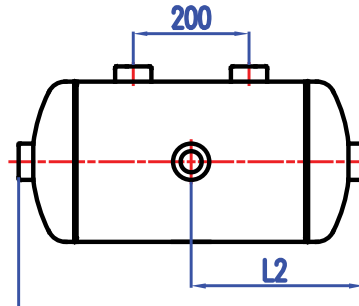
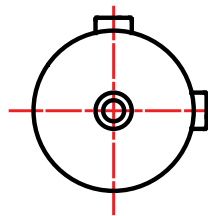
## AIR TANK

## HAVA TANKI



OEM / COMPARISON NO		LITER LİTRE	Ø	↔ L1 / L2			TYPE / TİP
SPA212	12,5 bar	60	300 mm	912 / 456 mm	18,5 kg	M22x1,5	



99306AP

DİĞER

## AIR TANK

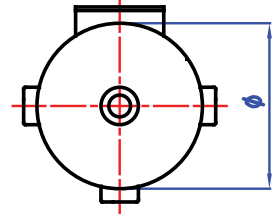
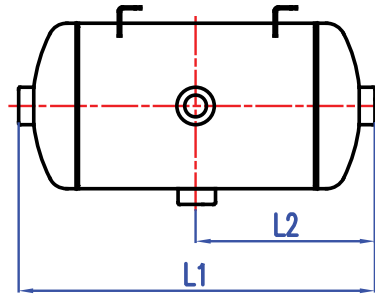
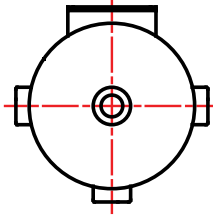
## HAVA TANKI

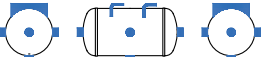
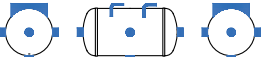

OEM / COMPARISON NO	 12,5 bar	LITER LİTRE 20	Ø 206 mm	↔ L1 / L2 709 / 355 mm	 11 kg	 M22x1,5	TYPE / TİP 
SPA181M	12,5 bar	20	206 mm	709 / 355 mm	11 kg	M22x1,5	





99307AP

DİĞER

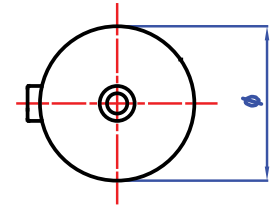
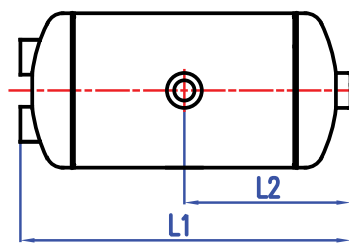
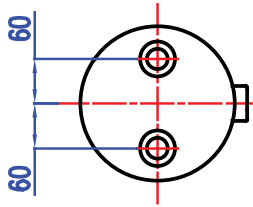
## AIR TANK

## HAVA TANKI



OEM / COMPARISON NO	 12,5 bar	LITER LİTRE 37	Ø 246 mm	↔ L1 / L2 852 / 431 mm	 14,3 kg	 M22x1,5	TYPE / TİP 
SPA1006	12,5 bar	37	246 mm	852 / 431 mm	14,3 kg	M22x1,5	





99308AP

**DiĞER**

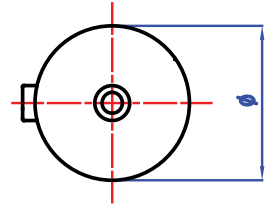
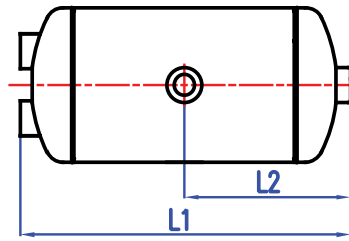
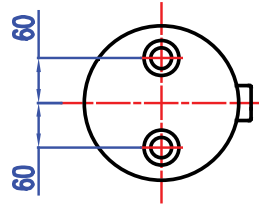
**AIR TANK**

**HAVA TANKI**



OEM / COMPARISON NO		LITER LİTRE	Ø	↔ L1 / L2			TYPE / TİP
SPA1009	12,5 bar	40	310 mm	620 / 315 mm	13,8 kg	M22x1,5	



99334AP

**DiĞER**

**AIR TANK**

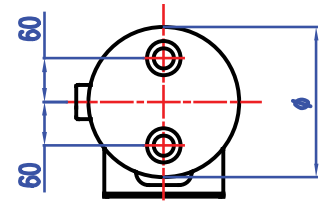
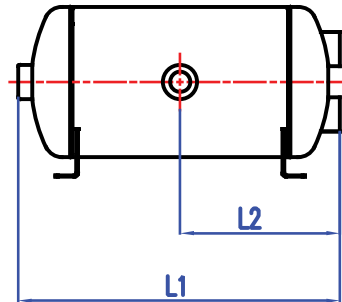
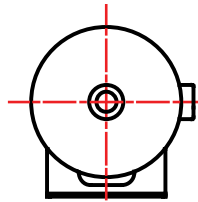
**HAVA TANKI**



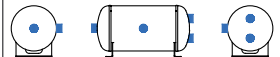

OEM / COMPARISON NO		LITER LİTRE	Ø	↔ L1 / L2			TYPE / TİP
X1107	12,5 bar	60	380 mm	610 / 310 mm	18,8 kg	M22x1,5	

## AIR TANK

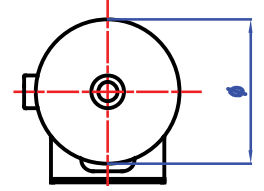
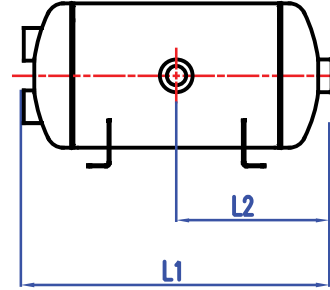
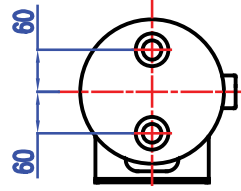
## HAVA TANKI



OEM / COMPARISON NO		LITER LİTRE	Ø	↔ L1 / L2			TYPE / TİP
X1108	12,5 bar	80	380 mm	790 / 400 mm	23 kg	M22x1,5	